

*DAIKIN*



**No. AT03C023EA**  
**Sep. 1.2005**

# **SPECIFICATIONS**

**COMPRESSOR**

**MODEL : JT335DA-Y1L@K4**

## 1. Range of Application and Assembly

### 1-1 Applied Range

The specifications provided here apply to the JT335DA-Y1L@K4 Hermetic Scroll Compressor.

### 1-2 Range of Assembly

As detailed in the following table:

	Name	Quantity	Plan No.	Remarks
1	Compressor	1	DA433—233—1	Including lubricant
2	Anti-vibration Rubber	(4)	DA429—903	Packaged and delivered separately
3	Spacer	(4)		
4	Terminal Connector	1	AT01C013-1	Comes with the unit
5	Terminal Connector Bolt	3	AT01C013-2	Comes with the unit

Note:

The pressure units in these specifications refer to the gauge pressure, unless stated otherwise.

## 2. Main Specifications

### 2-1 Ratings

Item		JT335DA-Y1L@K4
Rated Output	kW	9
Number of Poles	-	2
Displacement	cm <sup>3</sup> /r	184.2
Rated Speed(=Nominal Revolution)	r/min	2900 [50Hz]
Lubricant	-	DAPHNE FVC68D
Lubricant(Volume)	cm <sup>3</sup>	3000
Refrigerant	-	R407C
Inlet Pipe	mm	φ31.8 C1220T-O
Outlet Pipe	mm	φ19.1 C1220T-O
Weight (including refrigeration oil)	kg	71
Power Supply	-	3 phase at 50Hz
Rated Voltage	V	380 [50Hz]
External Wiring Connection Terminal	-	J.S.T. Round crimp terminal 8-5
Legal Rated Refrigerant Tonnage	t	2.89[50Hz]

## 3. Quality Specifications

### 3-1 Appearance and Dimensions

- The entire surface of the compressor has been coated with black paint (dipping and quick-dry painting). (coating membrane pressure of at least 15 μ m)
- Outer dimensions are shown on the attached diagrams of the exterior.

### 3-2 Leak Test and Pneumatic Resistance Test

The leak and pneumatic resistance tests of the compressor are conducted under the following conditions.

	Low-pressure side [MPa]	High-pressure side [MPa]
Leak Test	1.6	3.1
Pneumatic Resistance Test	10.5	10.5

### 3-3 Compressor Characteristics

Condition	Frequency [Hz]	Voltage [V]	Refrigerating Capacity [W]	Input [W]	Current [A]	Sound Pressure [dBA]	Vibration [μm]	Discharge Gas Pulsation [MPa]
Condition 1	50	380	33700	10810	18.3	72max.	75max.	± 0.02
Condition 2	50	380	34000	10700	18.1	72max.	75 max.	± 0.02

Note 1. The characteristics tests of the compressor are conducted under one of the following conditions.

Condition	Evaporating Temperature [°C]	Condensing Temperature [°C]	Superheating Degree [°C]	Super-cooling Degree [°C]
Condition 1	7.2	54.4	11.1	8.3
Condition 2	7.2	54.4	27.8	8.3

2. The refrigerating capacity, input, and current fluctuation within a range between 95% and 105%.

3. The sound pressure value is measured for the position one meter in front of the compressor at a height half , in use Daikin's genuine rubber mounting.

4. The vibration value is measured at the compressor legs attached, in use Daikin's genuine rubber mounting.

### 3-4 Motor Characteristics

- Insulation : Class E
- Starting Current : 142 A ( LRA : 125A ) (50Hz at 380 V)
- Starting Voltage : Minimum terminal voltage of 323V- 50Hz
- Starting Pressure : 1.94 MPa (high pressure)  
: 0.61 MPa (low pressure)
- Winding Resistance : 1.185Ω(average) at 75°C
- Insulation Resistance : 30 M min. (when dry), 1 M min. (when refrigerant flood the compressor.)
- Withstand Voltage : 2400V AC for 1 sec. and no dielectric breakdown impress

### 3-5 Others

- Moisture content : 1000mg [max.]
- Residual oil : 2000ppm max. (for the standard oil charge of 3000cm<sup>3</sup>)
- Residual chlorine amount : 15ppm max.(for the standard oil charge of 3000cm<sup>3</sup>)
- Residual amount : 100mg max.
- The compressor is filled up with nitrogen gas at a pressure of 0.01 MPa before shipping.

## 4. Compressor Operating Range

### 4-1 Operating Range

Refer to page 7 for the Compressor Operating Range.

### 4-2 Precautions

#### 1) Temperature

- Discharge port temperature : 140 max.
- Discharge port temp. : 155 max.(total accumulation period within 10 minutes)
- Discharge gas temperature range : Between Condensing temperature + 20°C and 130°C
- Oil temperature : 80°C max.
- Motor winding temperature : 120°C max.(Average temperature based up on resistance measure of motor winding )

#### 2) Power Supply

- Maximum voltage fluctuation : ±10% of rated voltage
- Maximum frequency fluctuation : ±2% of rated frequency

### 3) Refrigerant Systems

- Allowable refrigerant charge : 6.6 kg
- Design the refrigerant circuit so that the quantity of liquid refrigerant returning will be minimized.
- Oil concentration in oil sump during operation : Refer to the oil concentration range in 7-6.
- The compressor must be filled with refrigerant through the liquid pipe.
- The compressor may be filled with an excessive refrigerant charge, provided that circuit design is conducted with an appropriate device, such as an accumulator, is employed so that the compression mechanism will be free of excessive refrigerant.
- Counter pressure (i.e. suction pressure – discharge pressure) at pneumatic or leak test : 0.49 MPa max.

### 4) Others

- Maximum operating times : 12 times per hour
- Make sure that the shortest operation period is two minutes or more. Be sure to wait for at least three minutes to restart the compressor after turning it off.
- Mounting Angle :  $\pm 10^\circ$  max.
- Be sure to install a crankcase heater. The recommendable output is 72 W.
- For the air conditioner which is set up first or shut down over a long time, crankcase heater should be working over 6 hours before starting.
- Liquid height of residual compressor oil during operation should be maintained in the compressor external bottom at, at least, 48mm.
- Allowable water content : 250ppm max. (in liquid refrigerant)
- Allowable air infiltration amount : 500ppm max. (charged oil weight ratio)
- Allowable chlorine amount : 25ppm max. (charged oil weight ratio)
- Ester oil infiltration : 6000ppm max.(charged oil weight ratio)
- Although oil remaining in air conditioner system is recommended to be at 6000 ppm below, capillary jam test should be done. If not, our company are not responsible for the breakdown such as capillary jam etc, we kindly hope you comprehend and support.
- The accumulator and receptor must be cleaned, without press oil and rust-proof containing metals soap etc.
- Please apply the pipe and function parts ( Such as four way valve and other parts)in which residue is controlled.( The residue means oil and solid remains)

## 5. Protection Devices

The compressor must be installed with the following protection devices.

### 5-1 Discharge Pipe Thermostat

Attach a discharge pipe thermostat within 30 cm of the discharge pipe in order to prevent the temperature of the exhaust gas of the compressor from rising excessively due to overloading or gas supply interruption. The thermostat must be sensitive to an exhaust gas temperature of 140°C maximum .

### 5-2 Low Pressure Switch

Attach a low-pressure switch operating at a minimum pressure of 0 MPa in order to prevent the compressor from damage that may be caused by excessively low-pressure pumping.

### 5-3 Reverse-Phase Protector

The rotation of the compressor in the reverse direction is prohibited because the compressor may be damaged if rotated in the reverse direction. Attach a reverse-phase protector that detects the phase inversion of the compressor without operating the compressor.

#### 5-4 Internal Motor Protector (that had already been installed in the compressor)

- Manufacturer : UBUKATA INDUSTRIES CO., LTD
- Model : UP28UY081-400
- Temperature Characteristics : Open Temperature 170°C ± 5°C  
: Close Temperature 60°C ± 10°C
- Electrical Characteristics : Power supply Voltage 380v  
: Power supply Frequency 50Hz  
: Trip performance Specified In Page 10/17  
: Maximum Electrical Capacity 165A(380V)

#### 5-5 High Pressure Switch

In order to interrupt the operation of the compressor in the case of extraordinary pressure rises, attach a high-pressure switch that operates at the pressure values provided as leak test pressure values in 3-2.

### 6. Origins and Factory

Xi'an Daikin Qing'an Compressor Co., Ltd. (IN CHINA)

### 7. Possible Compressor Operating Range

- Refer to 7-5 on the following page for the possible compressor operating range.
- Possible operating range is divided into four areas (areas 1~4). The attendant conditions for each differ.
- Operate the compressor upon sufficient confirmation of the following attendant conditions, particularly for areas 2, 3 and 4.

#### 7-1 Area 1

Observe the precautions in 4-2.

#### 7-2 Area 2

Specifically confirm the following from the precautions in 4-2.

- Discharge port temperature: 140 max.
- Motor winding temperature: 120 max.
- Oil temperature: 80 max.
- Oil concentration: Within the oil concentration range in 7-6.

#### 7-3 Area 3

Specifically confirm the following.

Oil concentration: Within the oil concentration range in 7-6.

Liquid compressor: No liquid compressor

#### 7-4 Area 4

Specifically confirm the following.

- Continuous operating time: 10 minutes max.
- Oil concentration: Within the oil concentration range in 7-6.
- Liquid compression: No liquid compression
- Discharge port temperature: 140 max.
- Motor winding temperature: 120 max.

7-5 Possible Compressor Operating Range

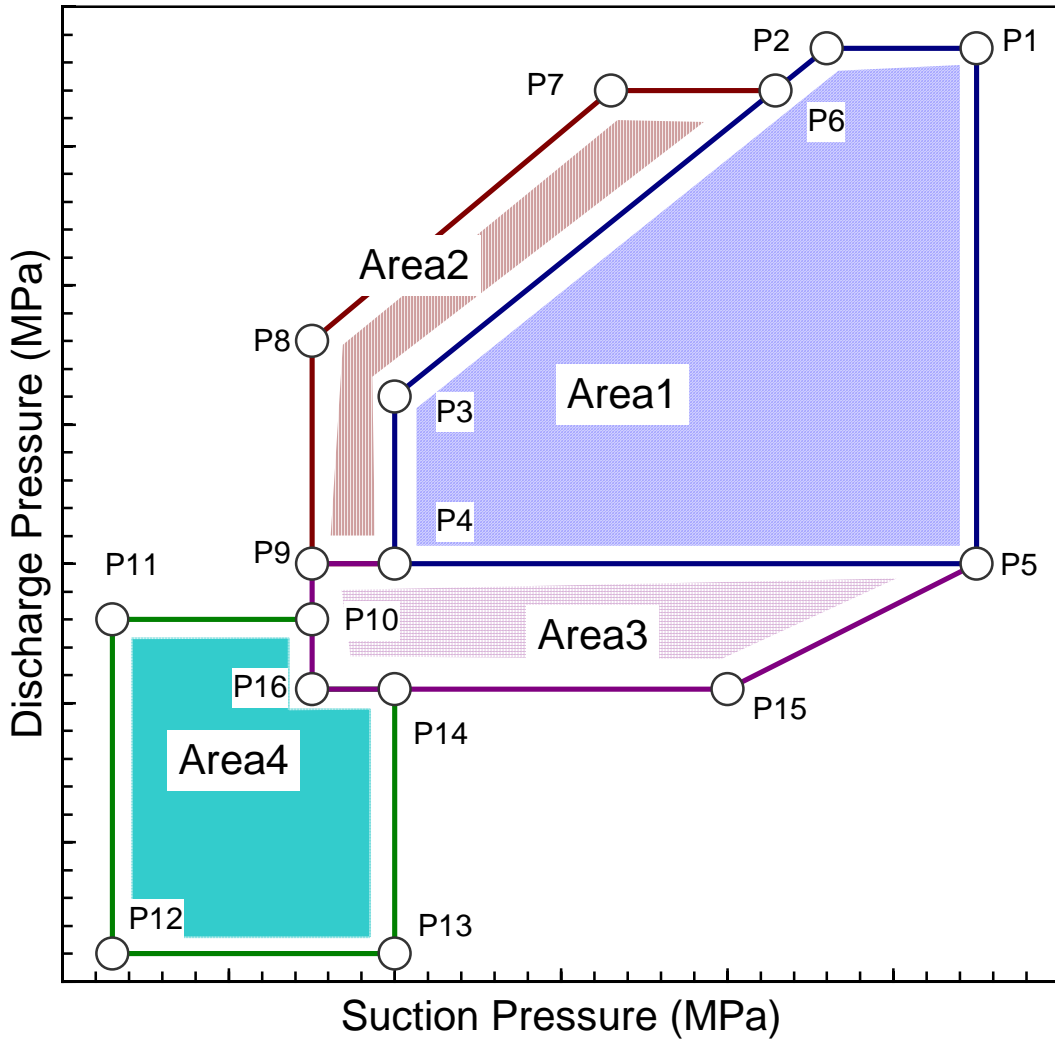

Point	P1	P2	P3	P4	P5	P6	P7	P8
Discharge pressure(MPa)	2.88	2.88	1.78	1.18	1.18	2.83	2.83	1.83
Suction pressure (MPa)	0.70	0.39	0.14	0.14	0.72	0.37	0.29	0.10

Point	P9	P10	P11	P12	P13	P14	P15	P16
Discharge pressure(MPa)	1.18	1.00	1.00	0.45	0.45	0.90	0.90	0.90
Suction pressure (MPa)	0.10	0.10	0.05	0.05	0.15	0.15	0.41	0.10

### 7-6 Oil Concentration Range

Operate the compressor with the following oil concentration range in the compressor oil trap.

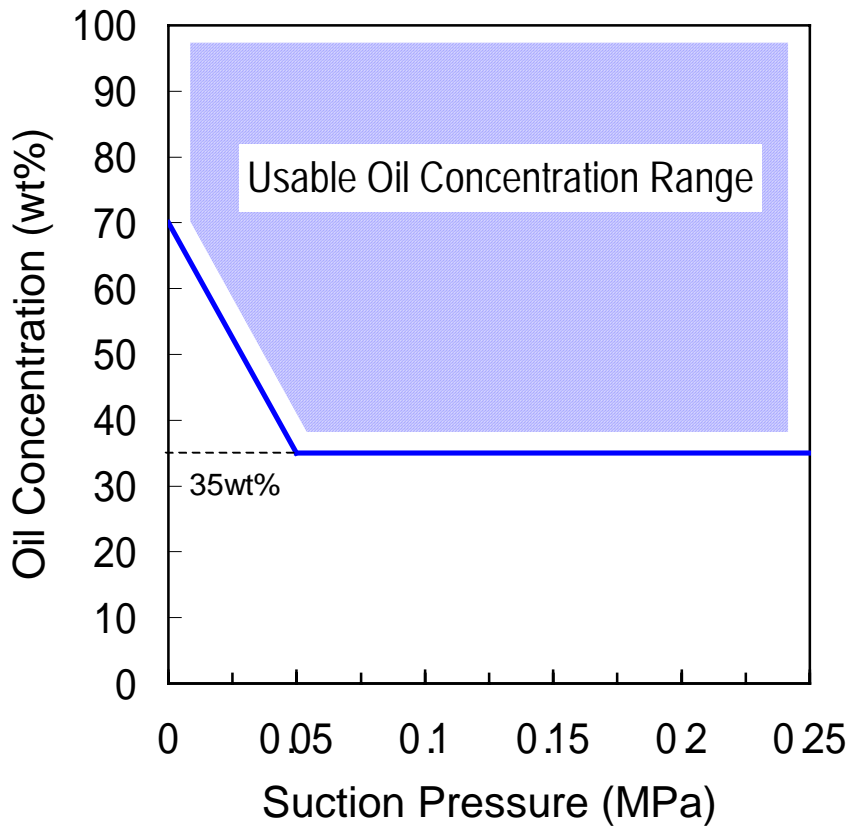

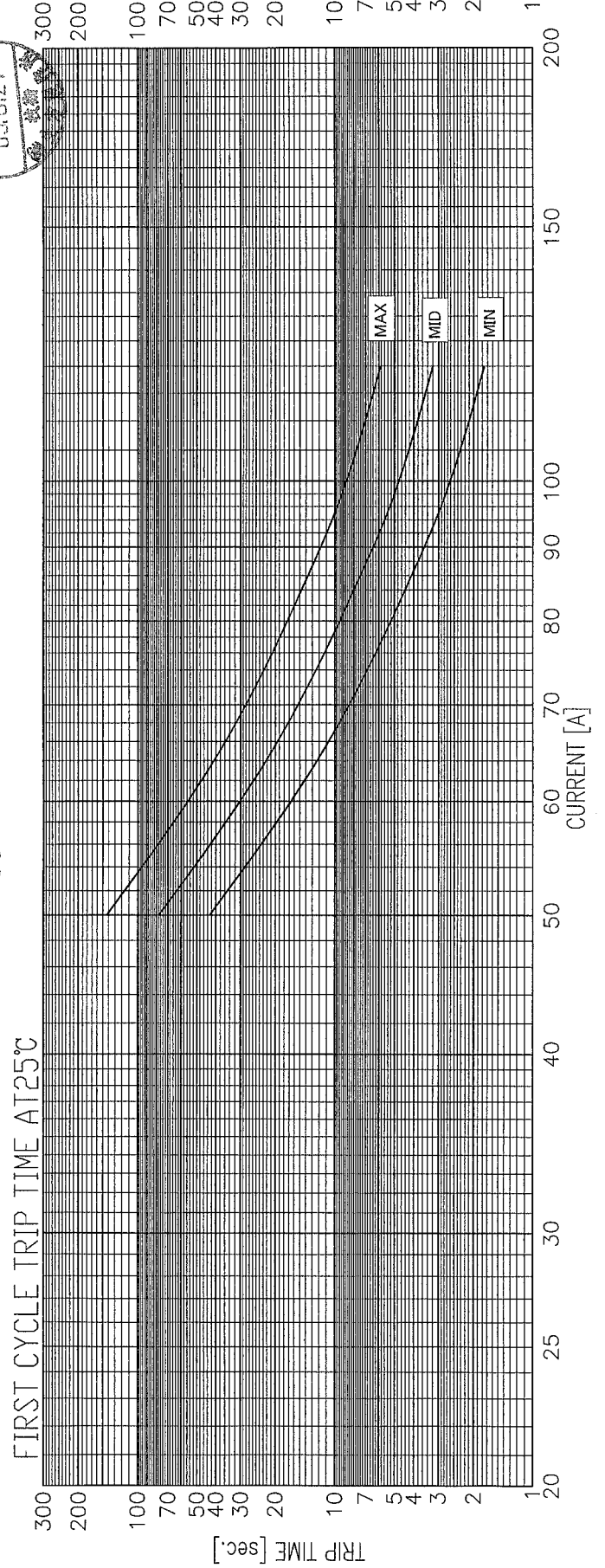
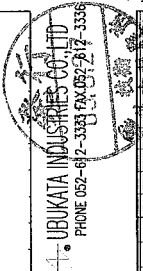
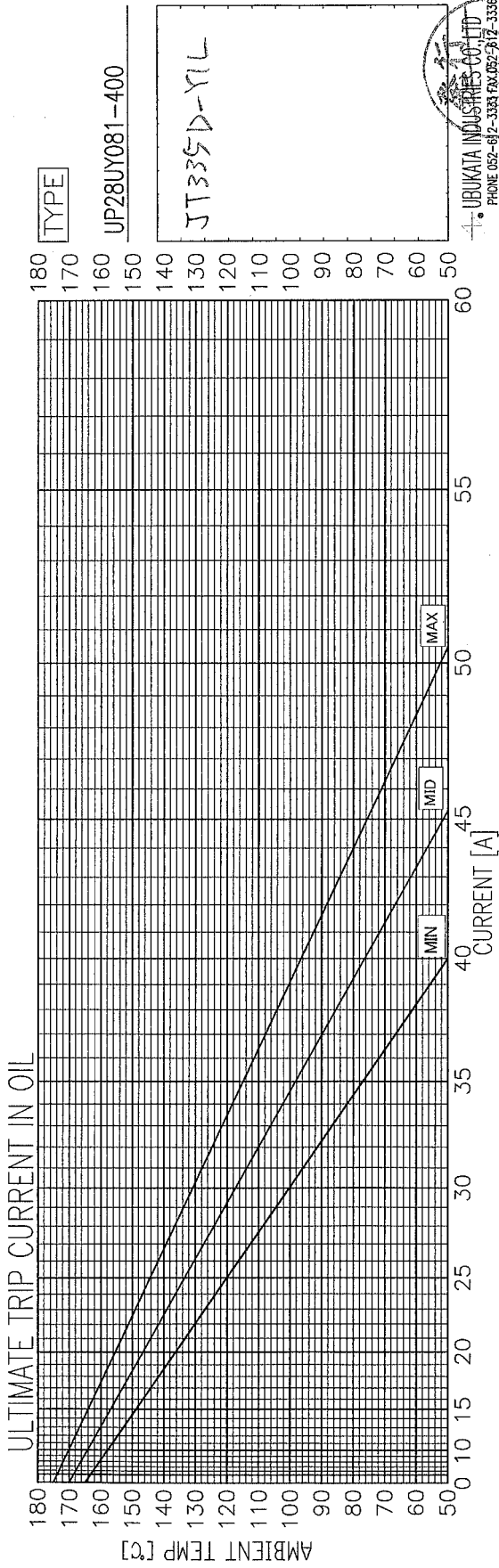

## Nameplate

The nameplate on the compressor will appear as follows.



## &lt;Guide&gt;

- |                |                                |
|----------------|--------------------------------|
| • MODEL        | <b>A</b> :Model Name           |
| • POWER SOURCE |                                |
| V              | <b>B</b> :Rated Voltage        |
| PHASE          | <b>C</b> :Phase number         |
| Hz             | <b>D</b> :Rated frequency      |
| • MFG.NO.      | <b>E</b> :Manufacturing number |

第3角法



表 1

機種名 MODEL	電圧 VOLTAGE RANGE (V)
JT3DA-Y1L	380

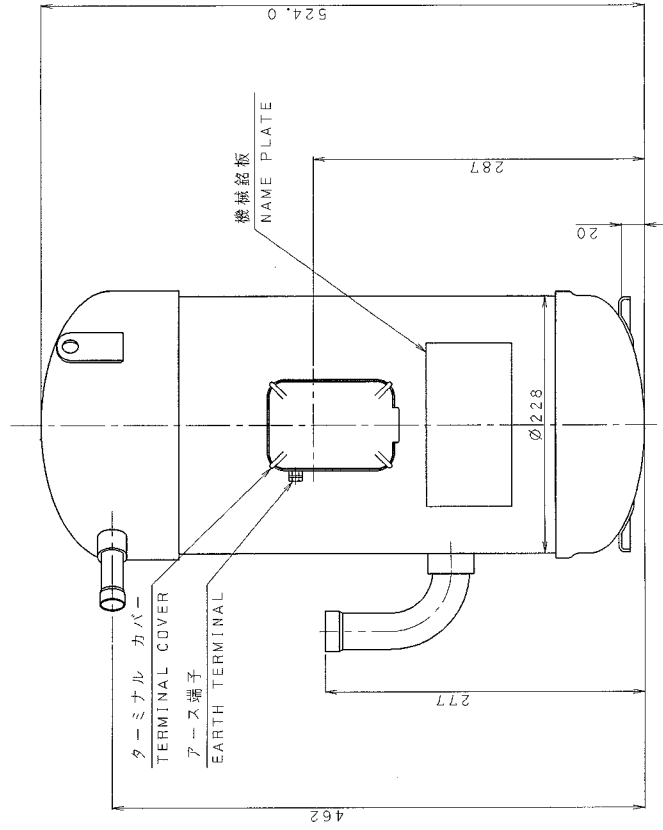
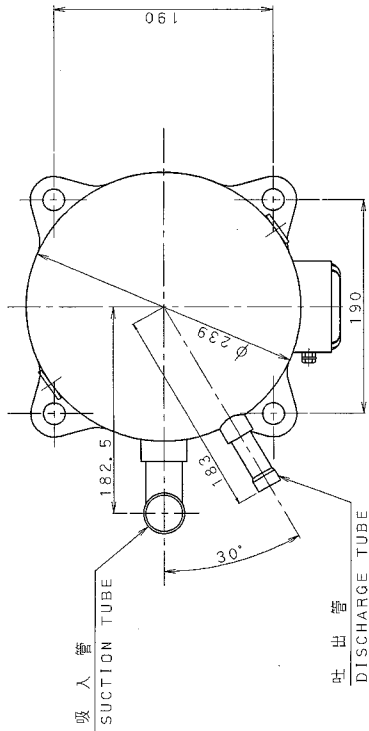
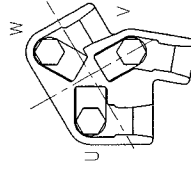

端子位置  
PHASE ARRANGEMENT

部番 ITEM NO.	1	2	3
機種名 MODEL	JT335DA-Y1L	JT300DA-Y1L	JT265DA-Y1L
定格出力 RATED OUTPUT (kW)	9	7.5	
排気量 SWAPT VOLUME (cm <sup>3</sup> /rev)	184.2	163.0	144.7
定格回転速度 RATED SPEED (1/min)		2900	
冷凍機油 REF. OIL GRADE	FVC68D		
冷凍機油充填量 REF. OIL CHARGE (L)	3.0		
制冷剂 REFRIGERANT	R407C		
吸入側管径 SUCTION CHIN	φ31.8 I. D.		
吐出側管径 DISCHARGE CHIN	φ19.1 I. D.		
全重量 NET WEIGHT (kg)	68	66	65
能力調整 CAPACITY CONTROL			
仕上色 COLOR	黒 BLACK		
電源 POWER SUPPLY	3 PHASE 50 HZ		
電圧 VOLTAGE RANGE (V)	参照表1 REFER TO TABLE 1		

尺 度	δ
作 成 日	03.07.01
発 行 日	
発 注 番 号	
製 作 数	

名 称	JT335DA-Y1L 外形図 (DI X 生産機) DIMENSIONS
管 理 番 号	DA433-233

ダイキン工業株式会社

03.7.1  
発行  
専用

CCM(製号)  
2

新規設計  
担当  
中島

△	
△	
△	

配布先

## The Dimensions of Suction and Discharge Connection

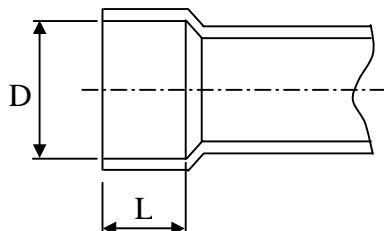

(mm)

Type	Suction Tube		Discharge Tube	
	D	L	D	L
JT335D(A)	31.88 $\begin{smallmatrix} +0.2 \\ 0 \end{smallmatrix}$	12 $\begin{smallmatrix} +2 \\ 0 \end{smallmatrix}$	19.17 $\begin{smallmatrix} +0.15 \\ 0 \end{smallmatrix}$	10 $\begin{smallmatrix} +2 \\ 0 \end{smallmatrix}$
JT300D(A)				
JT265D(A)				
JT236D(A)	25.53 $\begin{smallmatrix} +0.2 \\ 0 \end{smallmatrix}$			
JT212D(A)				



番号 Number	部品名 Part name	個数 Quantity	記 Comments
1	ターミナルコネクタ- Terminal Connector	1	
2	ターミナルコネクタ-用ボルト Terminal Connector Bolt	3	
3	圧縮機リード線 Compressor Lead Wire	1	客先調達 Procured by customer/client

M5ネジ深7<sup>+0.5</sup>  
M5 Screw Depth <sup>+0.5</sup>  
材質C3604BD  
Material C3604BD  
材質:T373J(Chang Chun Plastics)  
Material:T373J(Chang Chun Plastics)

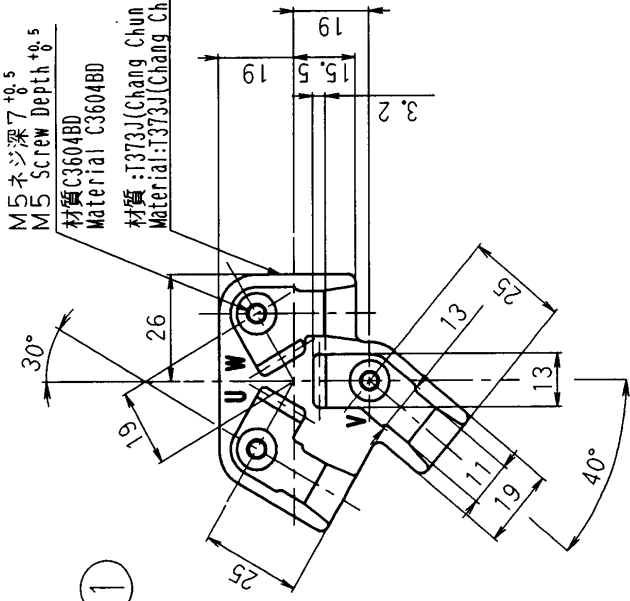

②

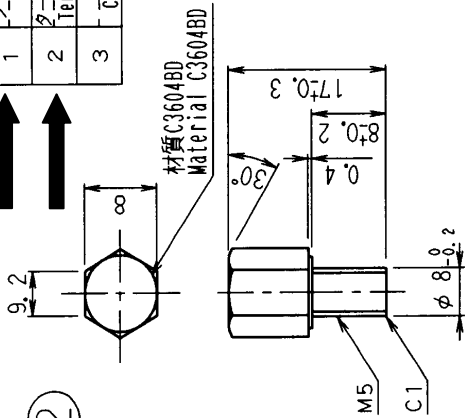

又ハ黄銅十字穴付ナベ小ネジ(M5×8)  
Or brass cross-recessed round head machine screw(M5×8)  
材質:C2700W-1/8H  
Material:C2700W-1/8H

③(参考寸法)

(Reference Measurements)

丸型裸圧着端子  
Ring Tongue Terminal (R-type) Non-insulated

日本圧着端子販売(株)

J. S. T. Mfg. Co., Ltd.

型番: 8-5, 14-5

Model number: 8-5, 14-5

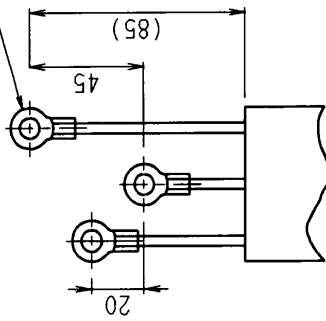

[取付要領]  
[Attachment Instructions]

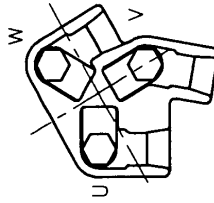

ターミナルコネクタ-用ボルトハ  
トルク 2.7±0.27N・m[27±2.7kgf・cm]ヲ締付テ下サイ。  
Tighten the terminal connector bolt  
with a torque of 2.7±0.27N・m[27±2.7kgf・cm].

手  
書  
キ  
二  
ヨ  
リ  
改  
正  
不  
可  
C  
A  
D  
図  
面

名	JT300D	ターミナル接続部品
称	DIMENSIONS	
管理 NO	AT01C013	
尺 寸	度	01.5.15
作 成 日	発 行 日	
受 注 番 号	製 作 数	
<b>ダイキン工業株式会社</b> 〒136-8505 東京都葛飾区新小岩5-1-1 TEL: 03-5621-5111 FAX: 03-5621-5112		

CCM(記入)  
2

新規設計  
担当  
中島

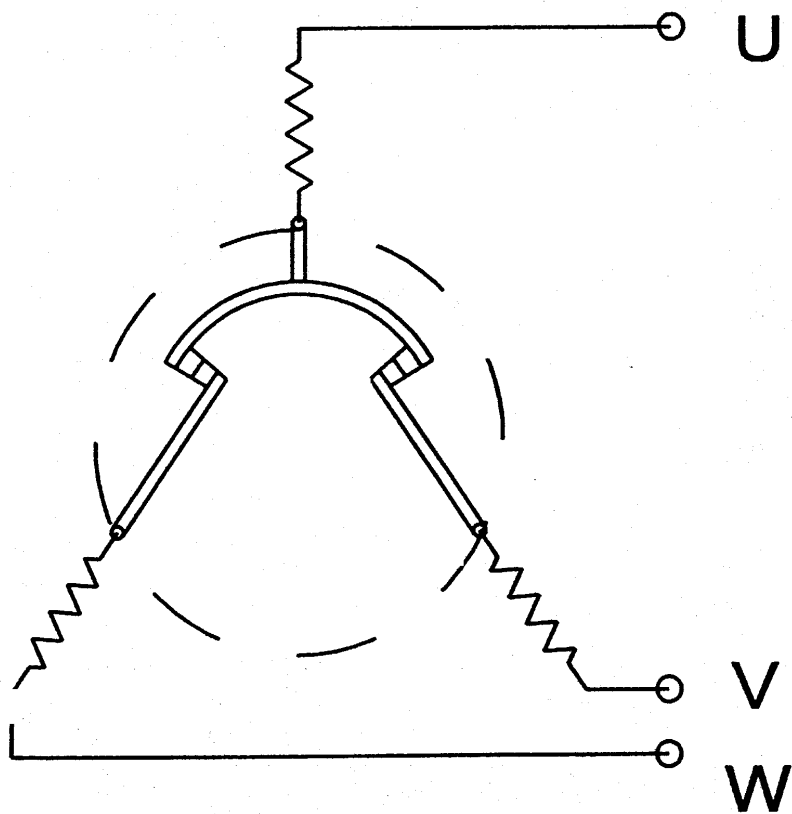



図番 DRW. NO.  
**DA433-4194**  
**A**

TC: 55°C    TE: 5°C    CAPACITY 29.8 [kW]    INPUT 10.70 [kW]    CURRENT 18.20 [A]

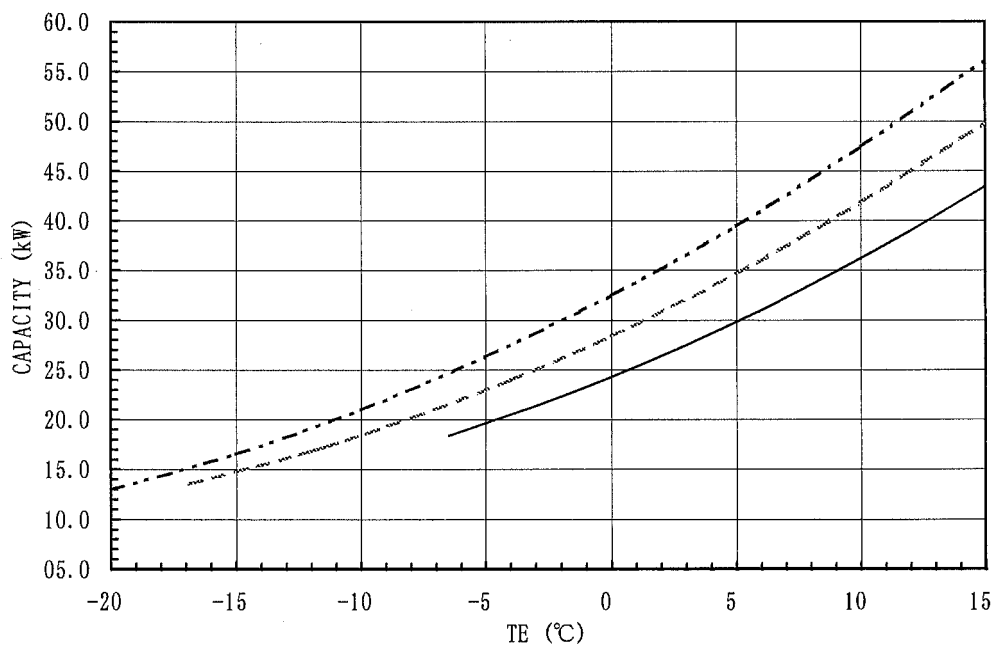
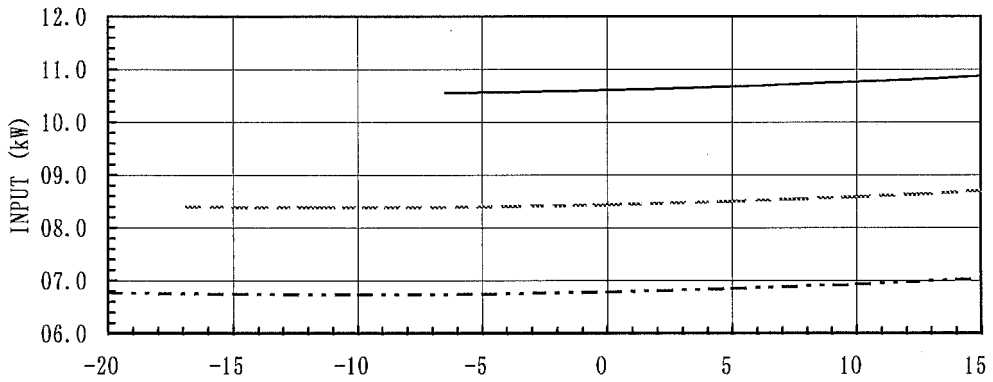
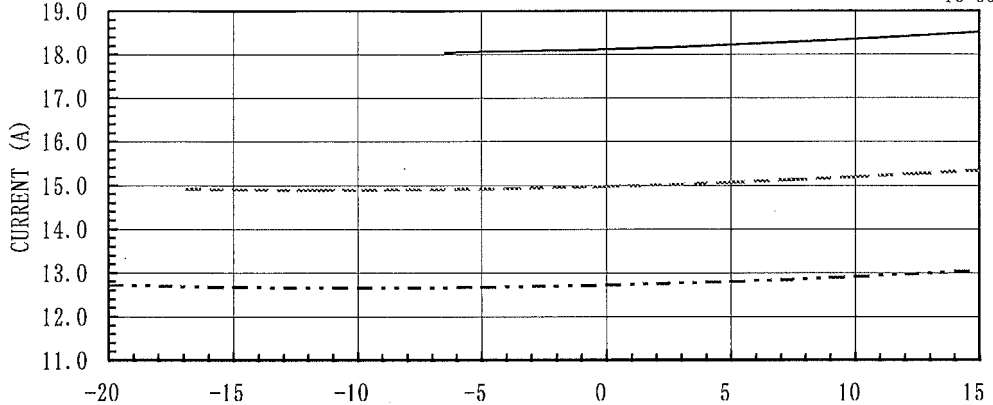

改正欄 REV.	
△	03・03・07
SI単位化 全面書換	
吉村	吉村
△	.
△	.

第 3 角 法 3RD ANGLE PROJECTION	尺 度 SCALE
作成日 DATE	VR 98 MO 02 DA 20
承認 APPROVED	照査 CHECKED
設計 DESIGNED	製図 DRAWN

**JT335DA-YE**  
 380 V- 50Hz    R407C  
 SH(°C) : 8    SC(°C) : 5  
**PERFORMANCE CURVES**  
 100% LOADING

配布先

吉田  
 103.7.-1

ダイキン工業株式会社  
 DAIKIN INDUSTRIES LTD

図番 DRW. NO.  
**DA433-4194**    **A**

